



Tune Fixed Height Desking

EINFACHHEIT IST DAS RESULTAT DER REIFE.

SIMPLICITY IS THE RESULT OF EXPERIENCE.

SCHILLER





Arbeits Tisch: 220 x 106 cm

Oberfläche: Echtholz Eiche

Gestell: graphit struktur

Eckverbindungsknoten: hochglanzchrom

Container: graphit / Echtholz Eiche

Work station: 220 x 106 cm

Top: oak veneer

Frame: graphite structure

Corner connection: mirror finish

Pedestal: graphite / oak veneer



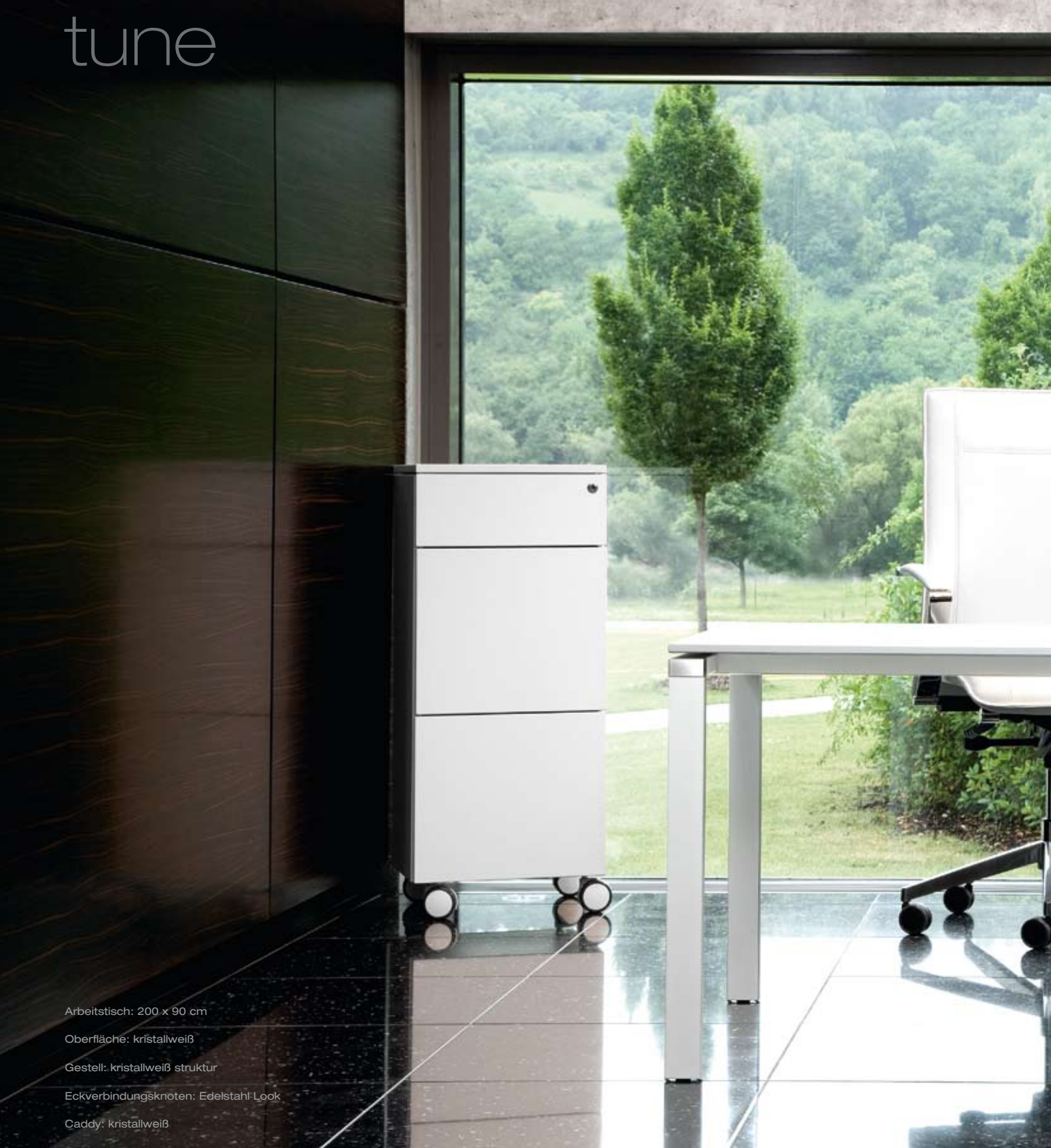

Arbeitstisch: 200 x 90 cm

Oberfläche: kristallweiß

Gestell: kristallweiß struktur

Eckverbindungsknoten: Edelstahl-Look

Caddy: kristallweiß

Work station: 200 x 90 cm

Top: crystal white

Frame: crystal white structure

Corner connection: stainless steel look

Caddy: crystal white





Arbeitstisch: 160 x 80 cm / 100 x 86 cm

Oberfläche: weißaluminium / Kante schwarz

Gestell: graphit struktur

Eckverbindungsknoten: hochglanzchrom

Work station: 160 x 80 cm / 100 x 86 cm

Top: aluminium white / black edge

Frame: graphite structure

Corner connection: mirror finish





Arbeitsfläche: 2x 160 x 80 cm und 160 x 50 cm

Oberfläche: kristallweiß / Kante schwarz

Gestell: kristallweiß struktur

Eckverbindungsknoten: hochglanzchrom

Container, Caddy und Sideboard: kristallweiß

Work stations: 2x 160 x 80 cm and 160 x 50 cm

Top: crystal white / black edge

Frame: crystal white structure

Corner connection: mirror finish

Caddy, pedestals and sideboard: crystal white



Mobiler Besprechungstisch

höhenverstellbar

Ø 80 | 100 | 120 cm

Oberfläche: kristallweiß / Kante schwarz

Gestell: kristallweiß struktur



mobile conference desk

height adjustable

Ø 80 | 100 | 120 cm

Top: crystal white / black edge

Frame: crystal white structure



Arbeitsstische: 160 x 80 cm
 Oberfläche: kristallweiß / Kante schwarz
 Gestell: kristallweiß struktur
 Eckverbindungsknoten: Edelstahl Look
 Caddies: kristallweiß

*Work stations: 160 x 80 cm
 Top: crystal white / black edge
 Frame: crystal white structure
 Corner connection: stainless steel look
 Caddies: crystal white*



Arbeitsstisch: 160 x 80 cm
 Oberfläche: kristallweiß
 Gestell: kristallweiß struktur
 Eckverbindungsknoten: Edelstahl Look
 Rückwand: transluzent
 Container: kristallweiß

*Work station: 160 x 80 cm
 Top: crystal white
 Frame: crystal white structure
 Corner connection: stainless steel look
 Modesty panel: translucent
 Pedestal: crystal white*



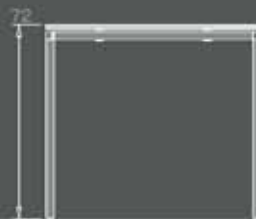

Standard



Option: mit Höheneinstellung
Option: with height adjustment



Standard



Option: mit Höheneinstellung
Option: with height adjustment

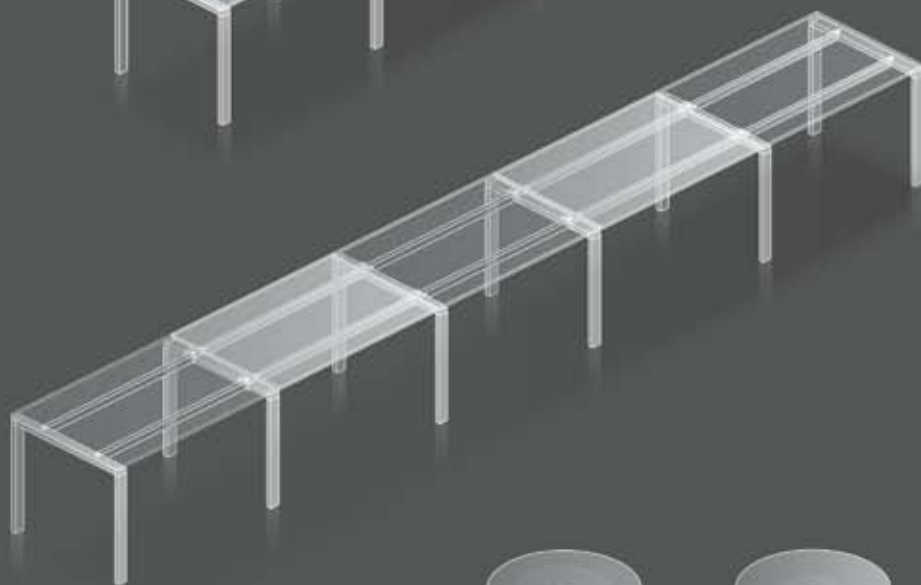

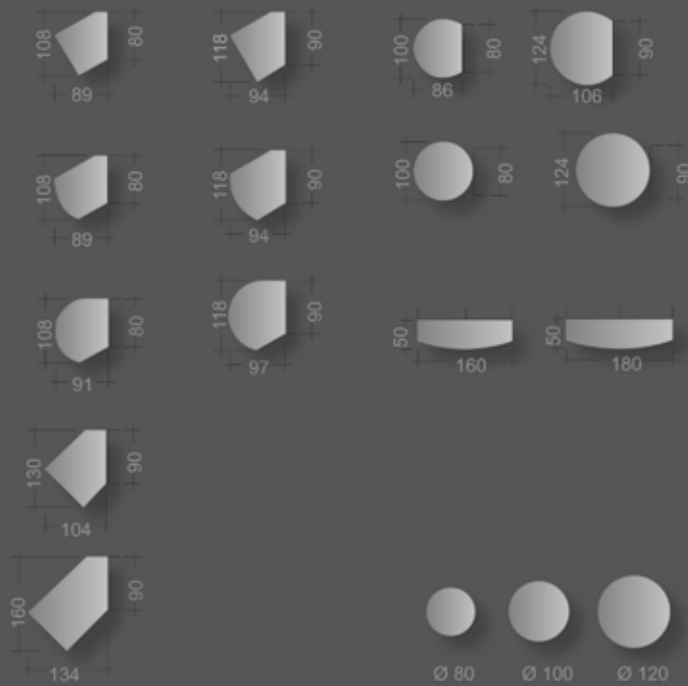
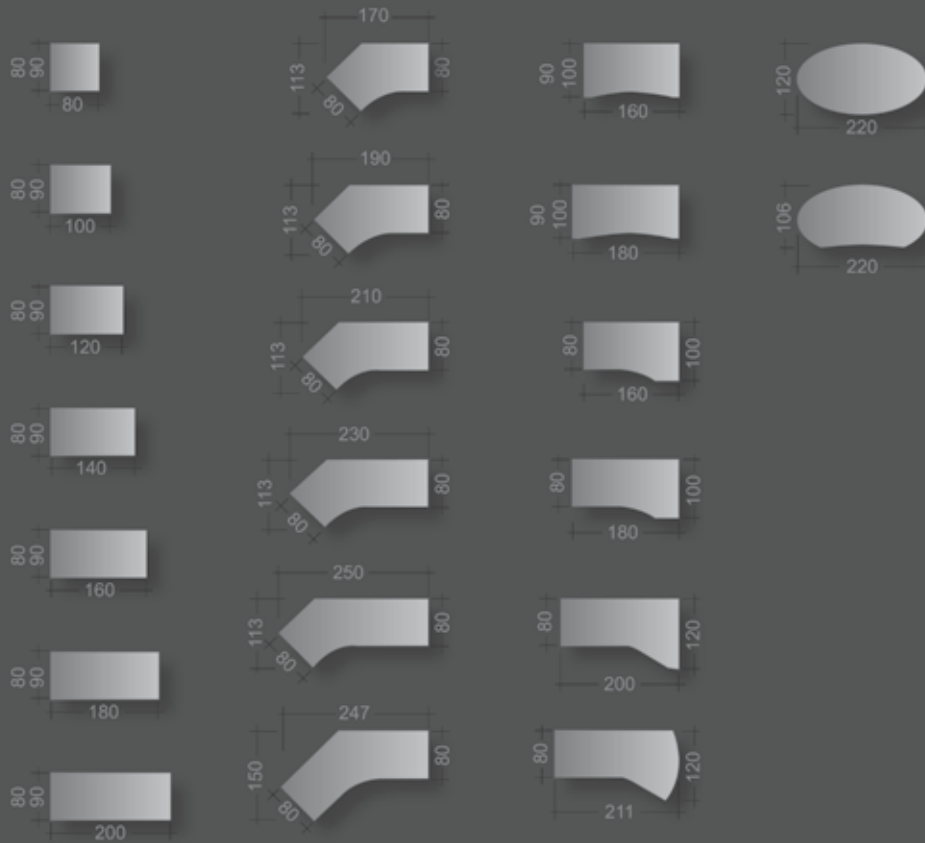

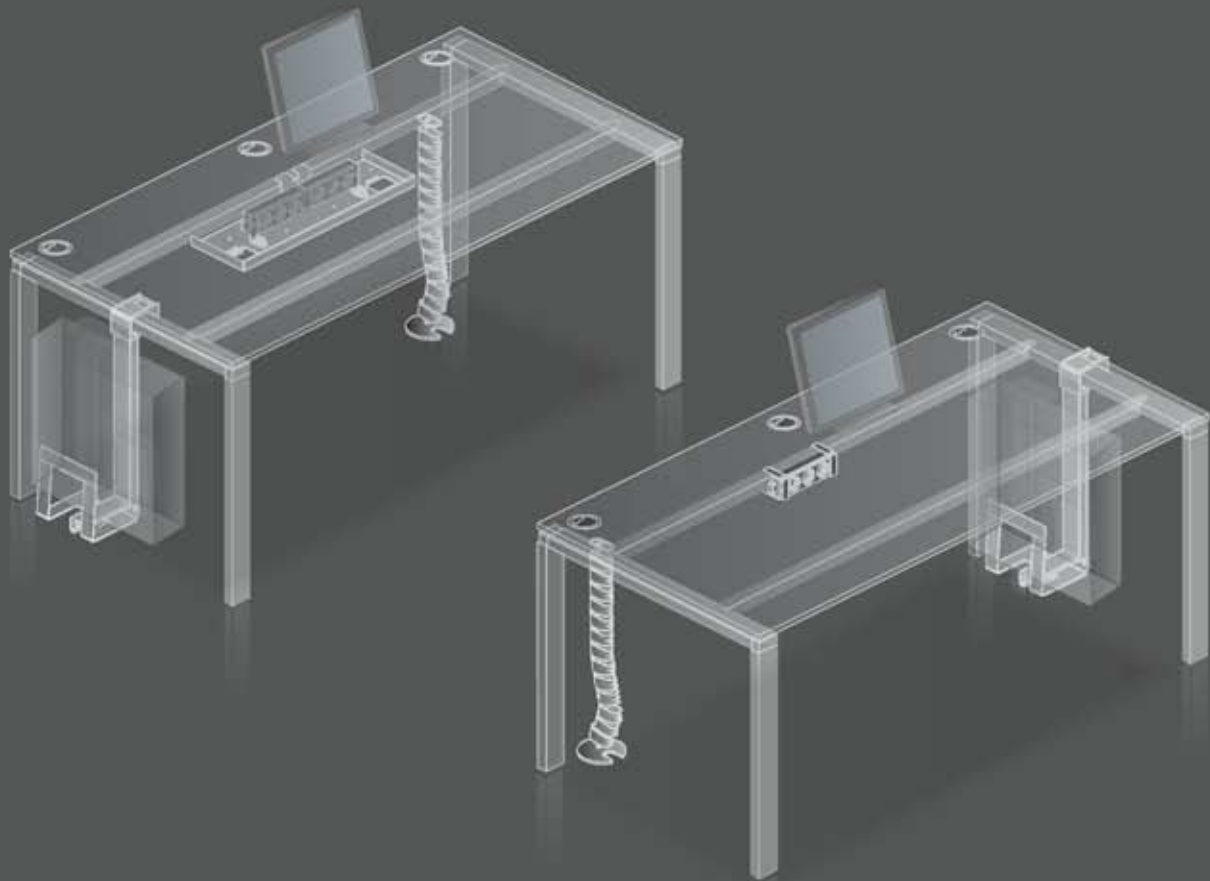

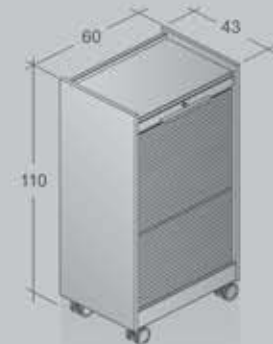
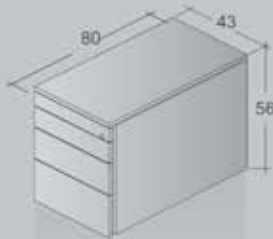



tune

Arbeitsfläche: 160 x 80 cm

Oberfläche: kristallweiß

Gestell: kristallweiß struktur

Eckverbindungsknoten: Edelstahl Look

Caddies: kristallweiß / apfelgrün

Work stations: 160 x 80 cm

Top: crystal white

Frame: crystal white structure

Corner connection: stainless steel look

Caddies: crystal white / apple green





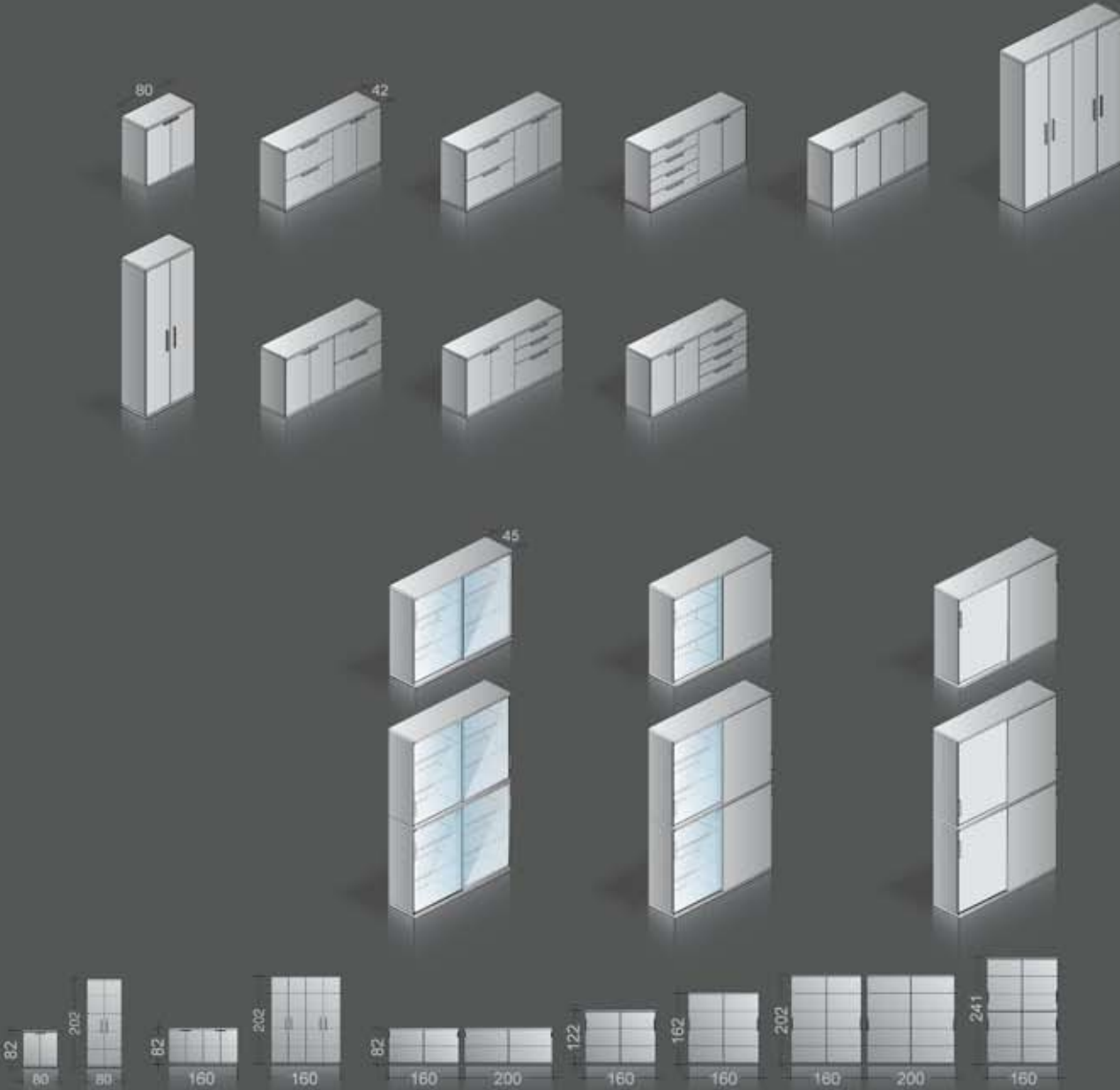

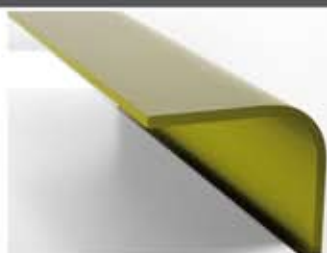



Arbeitstisch: 160 x 80 cm

Oberfläche: kristallweiß / Kante schwarz

Gestell: kristallweiß struktur

Eckverbindungsknoten: kristallweiß

Container: kristallweiß / orangerot

Work station: 160 x 80 cm

Top: crystal white / black edge

Frame: crystal white structure

Corner connection: crystal white

Pedestal: crystal white / orange red



Arbeits Tisch: 230 x 113 cm

Oberfläche: kristallweiß

Gestell: helium

Eckverbindungsknoten: hochglanzchrom

Container: kristallweiß

Work station: 230 x 113 cm

Top: crystal white

Frame: helium

Corner connection: mirror finish

Pedestal: crystal white

Impressum:

Design tune: Michael Wirsing
Design iScube: André Vomdran

Konzept & Realisierung:
ehlers-media.com

Fotografie:
Rolf Nachbar (on location)
Thomas Oswald (Studio)
Gerd Heinlein (Details)
Some of the location
kindly provided by
Krick Verlag | Welt AG Eibelstadt



Arbeitstisch: 200 x 80 cm / 120 x 80 cm

Work station: 200 x 80 cm / 120 x 80 cm

Oberfläche: kristallweiß

Top: crystal white

Gestell: kristallweiß struktur

Frame: crystal white structure

Eckverbindungsknoten:

Corner connection:

kristallweiß struktur

crystal white structure

Container: kristallweiß

Pedestal: crystal white





Arbeitstisch: 180 x 90 cm

Oberfläche: Zebrano Dekor / Kante schwarz

Gestell: kristallweiß struktur

Eckverbindungsknoten:

kristallweiß struktur

Container: kristallweiß

Work station: 180 x 90 cm

Top: zebrano decor / black edge

Frame: crystal white structure

Corner connection:

crystal white structure

Pedestal: crystal white



tune





Arbeitsfläche: 250 x 113 cm

Oberfläche: kristallweiß

Gestell: helium

Eckverbindungsknoten:

hochglanzchrom

Container und Sideboard:

kristallweiß

Work stations: 250 x 113 cm

Top: crystal white

Frame: helium

Corner connection: mirror finish

Pedestal and sideboard:

crystal white



Arbeitstische: 160 x 80 cm

Oberfläche: kristallweiß

Gestell: kristallweiß struktur

Eckverbindungsknoten: Edelstahl Look

Caddies: kristallweiß / orangerot

Work stations: 160 x 80 cm

Top: crystal white

Frame: crystal white structure

Corner connection: stainless steel look

Caddies: crystal white / orange red





For more information,
give us a call or visit our website, coronagroupinc.com.



where custom is standard
p. 205.941.1942
Birmingham, AL
info@coronagroupinc.com
coronagroupinc.com